

Power Window

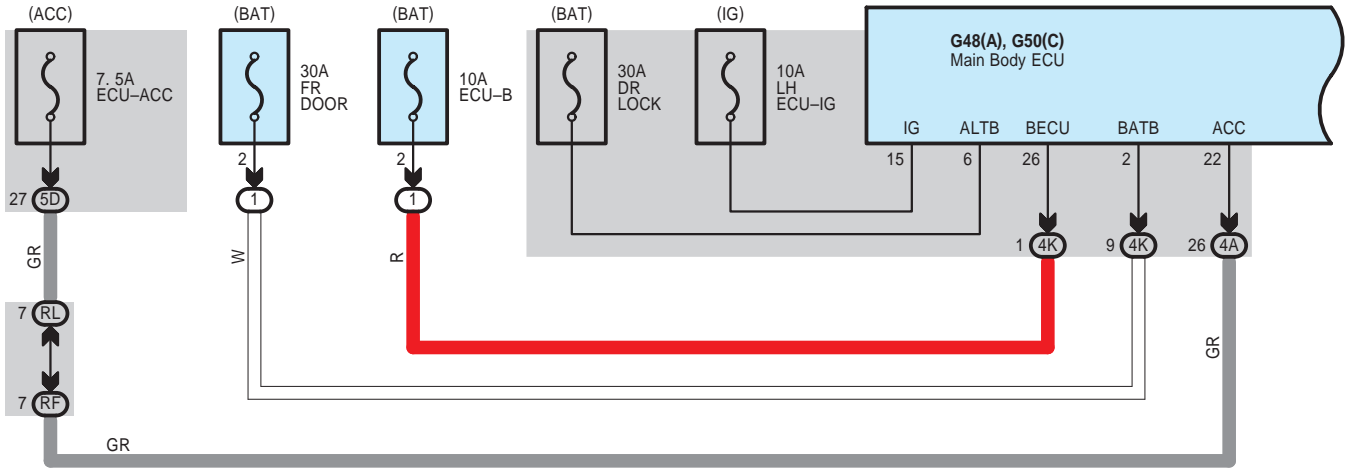

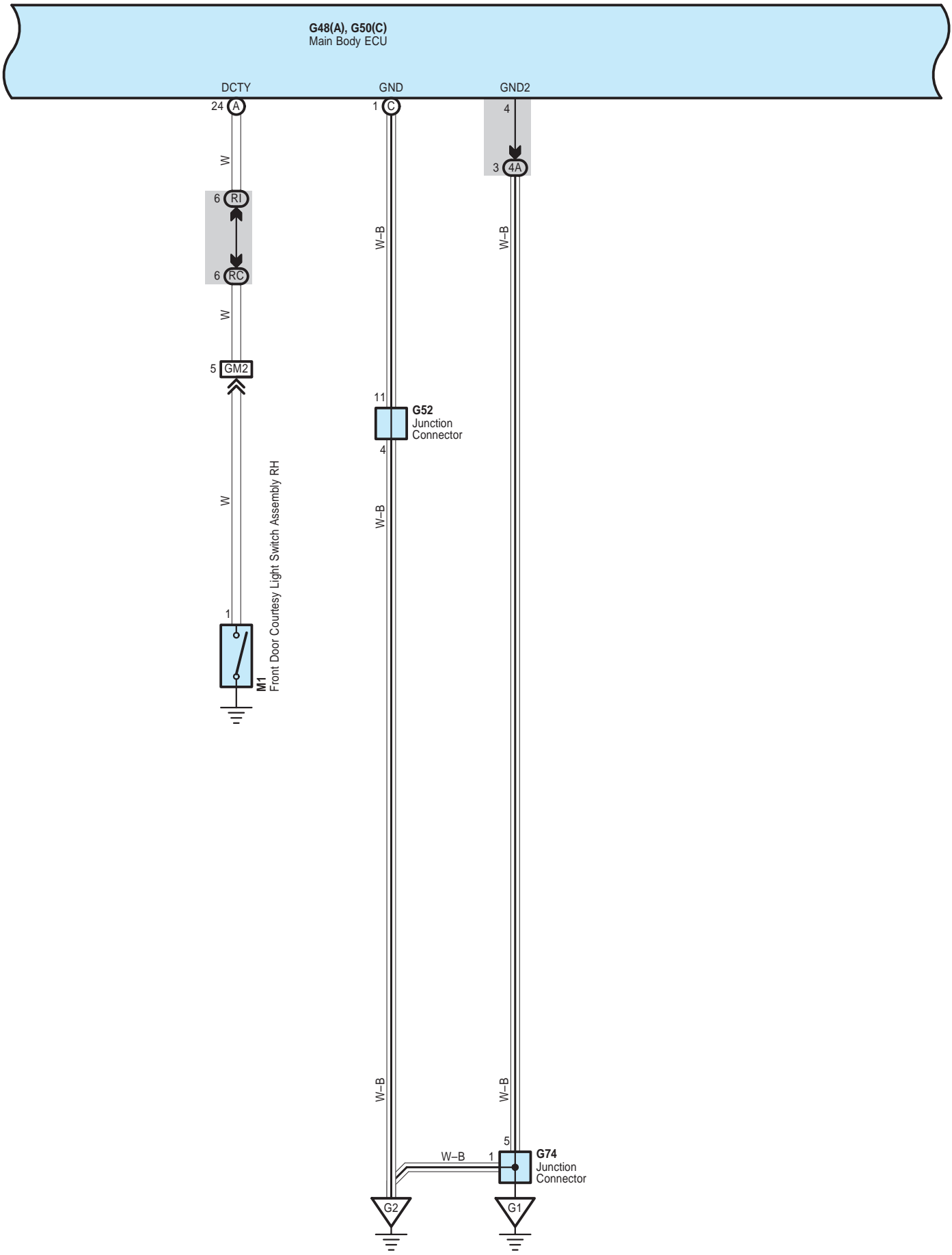

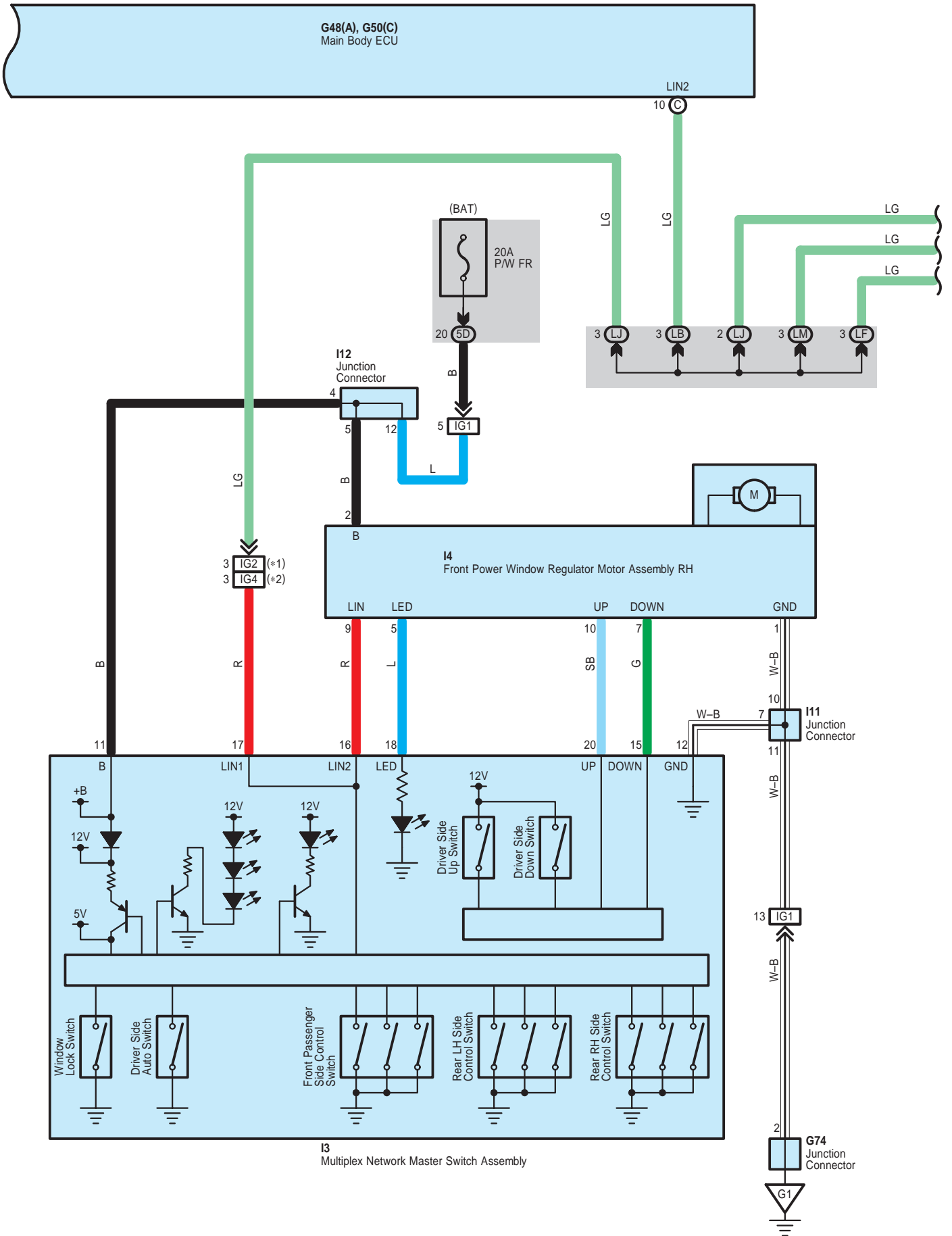

Power Window

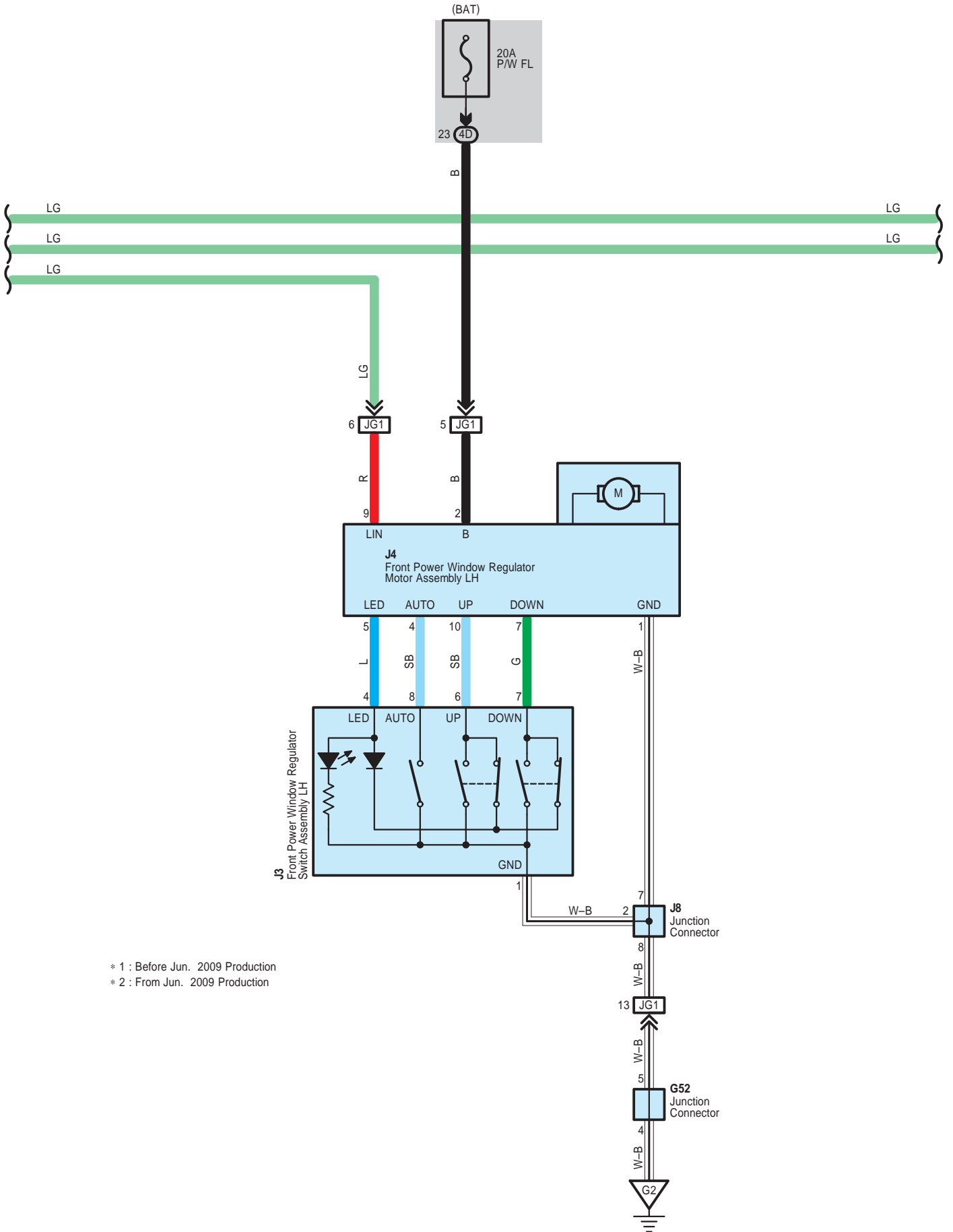

- * 1 : Before Jun. 2009 Production
- * 2 : From Jun. 2009 Production

Power Window

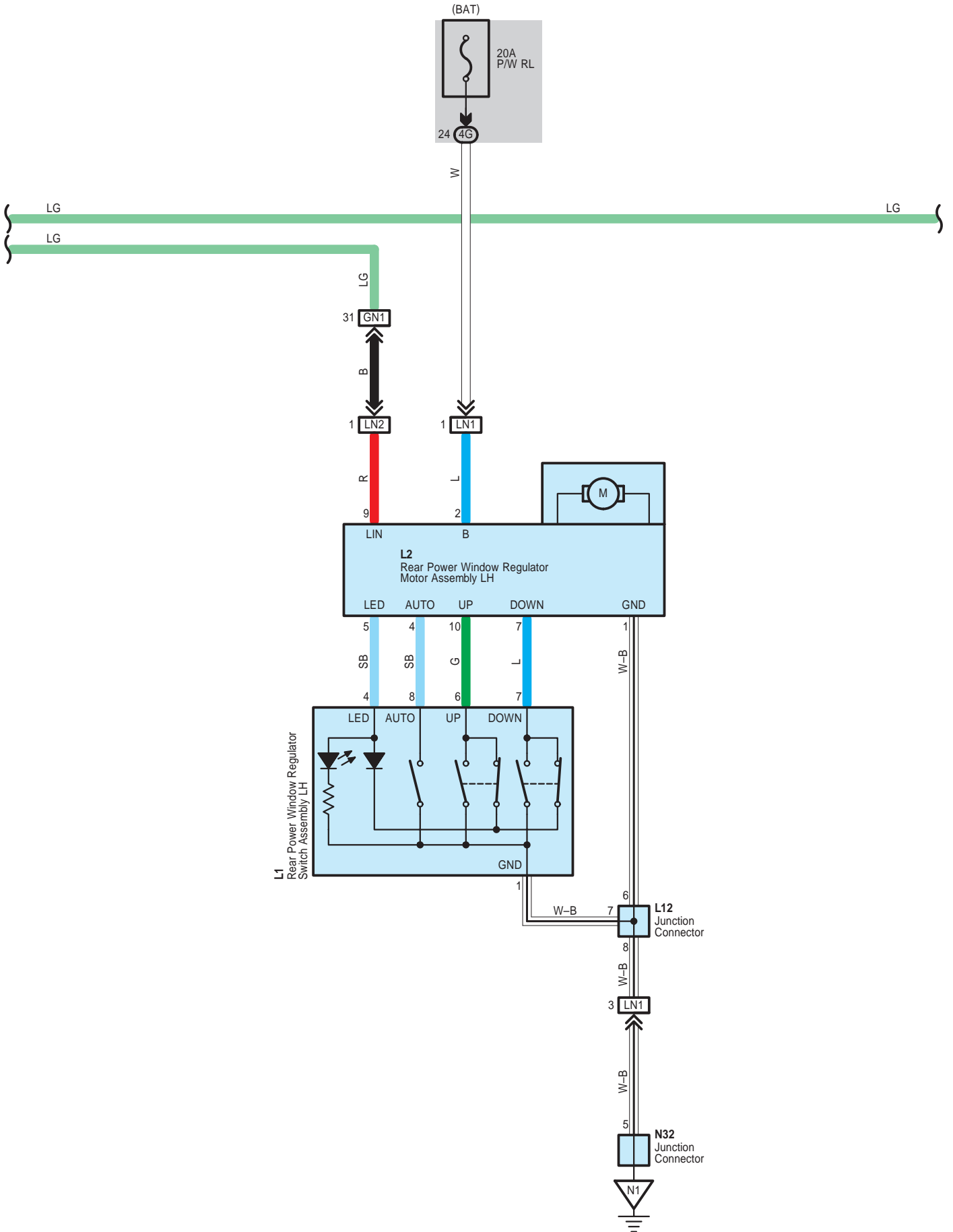

* 1 : Before Jun. 2009 Production
 * 2 : From Jun. 2009 Production

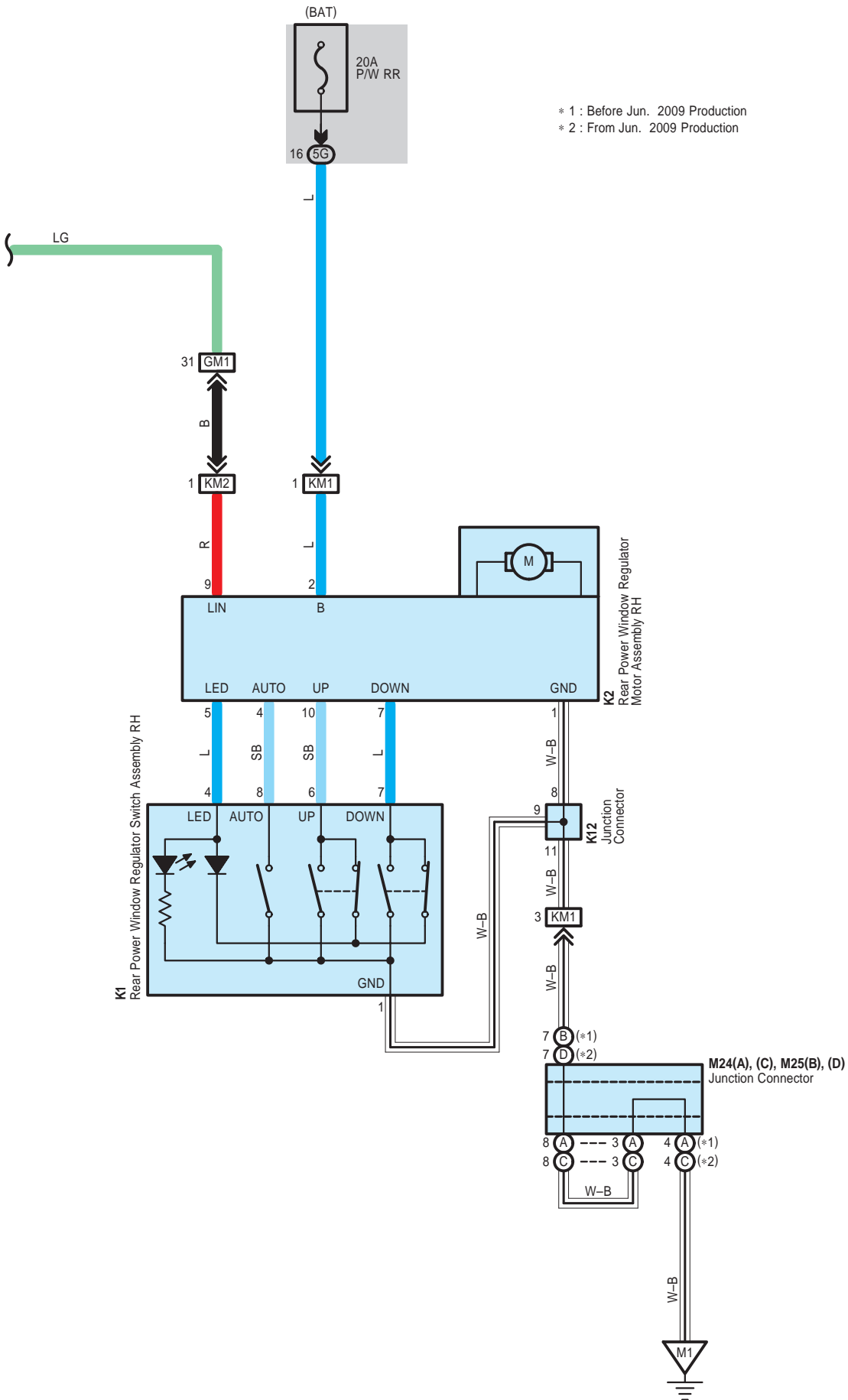

Power Window

G 48
White

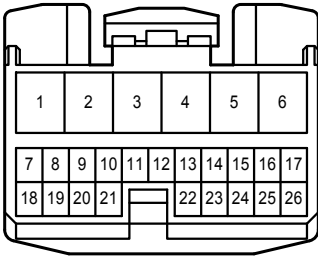

G 50
White

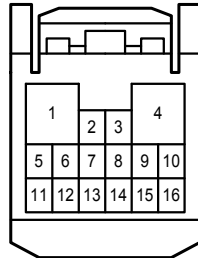

G 52
Gray

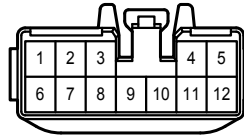

G 74
White

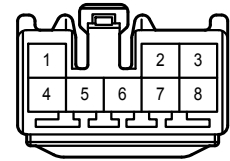

I 3
White

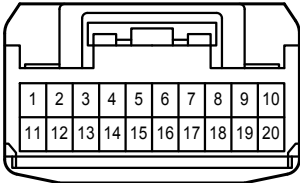

I 4
White

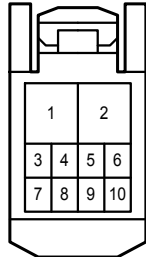

I 11
Blue

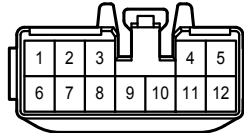

I 12
Black

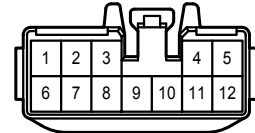

J 3
White

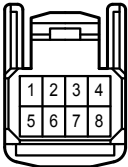

J 4
White

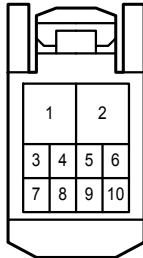

J 8
Blue

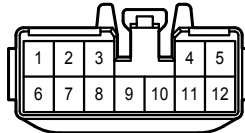

K 1
White

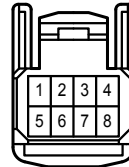

K 2
White

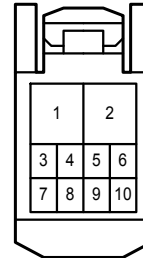

K 12
Blue

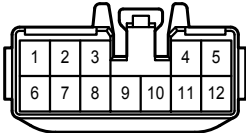

L 1
White

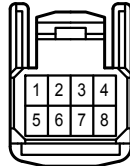

L 2
White

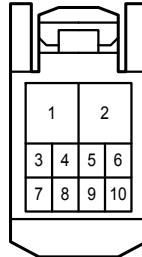

L 12
Blue

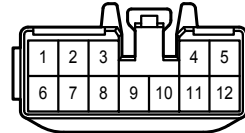

M 1
White



M 24
Blue

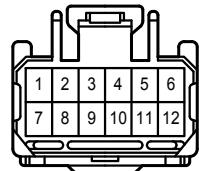

M 24
Blue

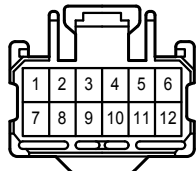

M 25
Blue

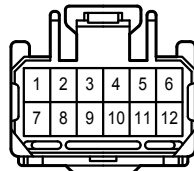

M 25
Blue

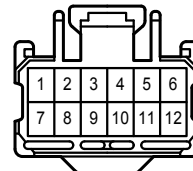

(From Jun. 2009 Production)

(Before Jun. 2009 Production)

(From Jun. 2009 Production)

(Before Jun. 2009 Production)

Power Window

N 32
Black

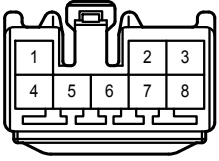

4A
White

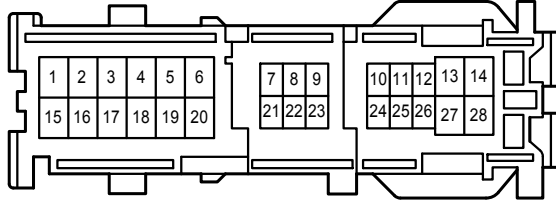

4D
White

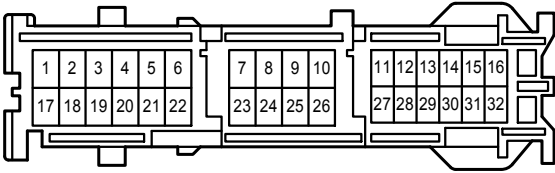

4G
White

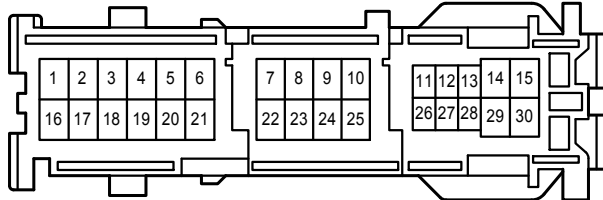

4K
Gray



5D
White

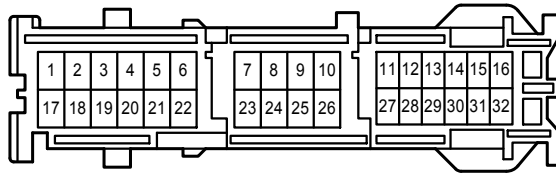

5G
White

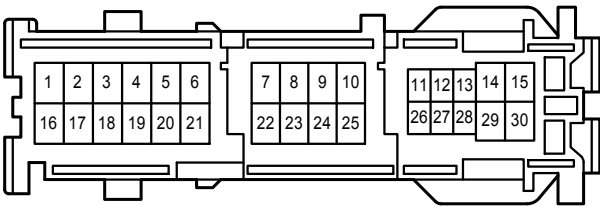

LB
Gray

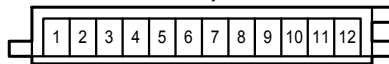

LF
Gray

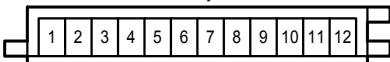

LJ
Gray

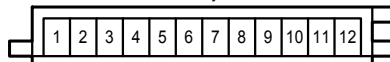

LM
White

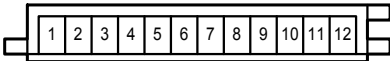

RC
White

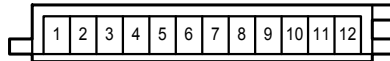

RF
Gray

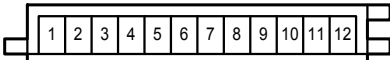

RI
White

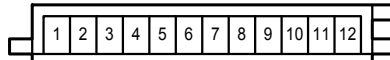

RL
Gray

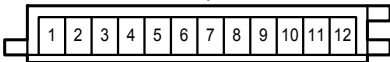

Power Window

GM1
White

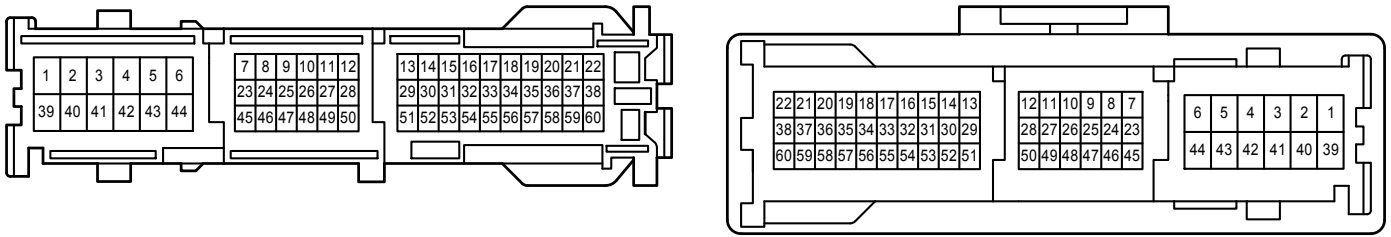

GM2
White

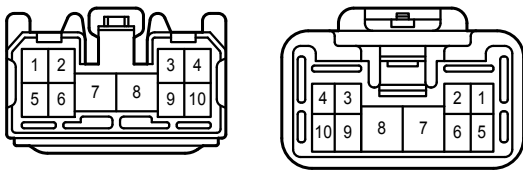

GN1
White

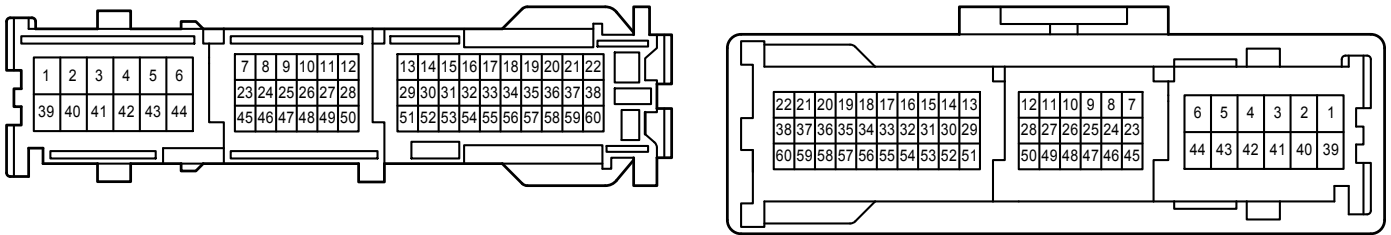

IG1
White

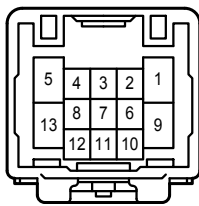
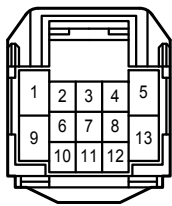

IG2
Gray

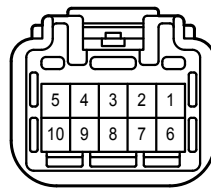
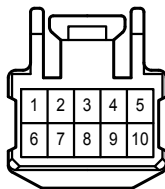

IG4
Gray

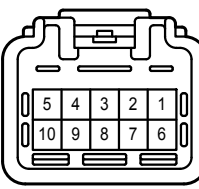
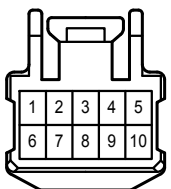

JG1
White

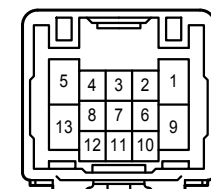
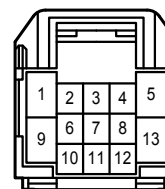

Power Window

KM1
White

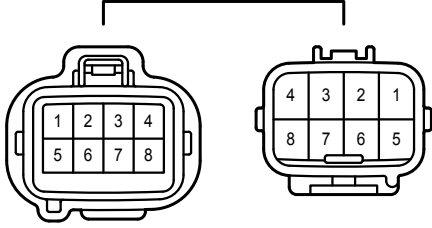

KM2
Black

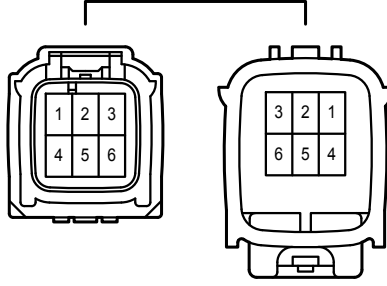

LN1
White

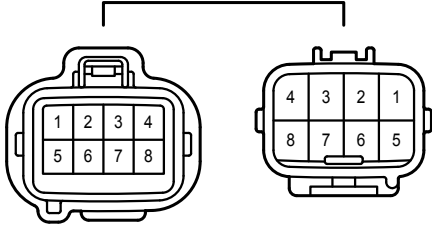

LN2
Black

